

### OPTICS

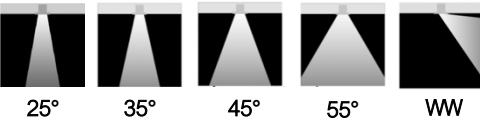

### CCT



### TECHNICAL SPECIFICATION

Minimum profile downlight with metal conduit and driver included for easy remodel or new construction installation.

### SPECIFICATIONS

- Construction: Die-cast Aluminum
- Optics: PMMA Lens
- Power: 20W Input: 120-277 VAC, 50/60Hz
- CCT: 2700K, 3000K, 3500K, 4000K
- CRI: +90
- LED Source: 853lm-1362lm
- Beam Angle: 25°/35°/45° /55° /WW
- Adjustable fixture from 0° -30° Tilt – Rotation 0°-358°
- Dimming Options: DALI – TRIAC – 0-10V
- Light Source: Integrated LED Lens: TIR lens
- Rated Life: L80 >50000 Hours
- Finish: Electrostatically Powder Coated: White, Black, Hazel and Gold (RAL options available).
- Standards: ETL, cETL, Wet and Damp Location Listed
- Fixed and Wall wash – Wet Location Rated
- Adjustable - Damp Location Rated

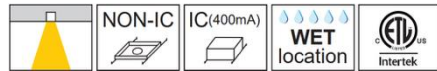

### FINISHES



WW - White

BB - Black

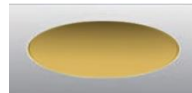

WW - Gold



BB - Haze

### 1. Trim Type

- LUZ3-RFTL** = Round Reflector, Fixed, Trimless (1362lm) **Wet**
- LUZ3-RATL** = Round Reflector, Adjustable, Trimless (1350lm) **Damp**
- LUZ3-RWWTL** = Round Reflector, Wall Wash, Trimless (853lm) **Wet**

### 2. Color Temperature

- 27** = 2700K  
**30** = 3000K  
**35** = 3500K  
**40** = 4000K

### 3. Optic

- NS** = 25°\*  
**N** = 35°\*  
**M** = 45°\*  
**W** = 55°\*  
**WW** = Wall Wash\*\*

### 4. Finish

- WW** = White Reflector  
**BB** = Black Reflector  
**HZ** = Haze Reflector  
**GD** = Gold Reflector

### 5. Dimming

Please see Housing Ordering Sheet

### Accessories

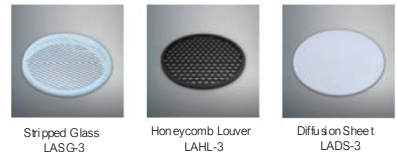

\* Not available for LUZ3-RWWTL

\*\* Only available optic for LUZ3-RWWTL

Example: **LUZ3-RFTL-30-M-WW** = 3" Round Trimless Fixed Downlight – 3000K – 45° Optic – White Reflector

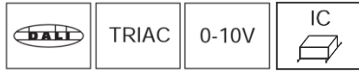

New Construction

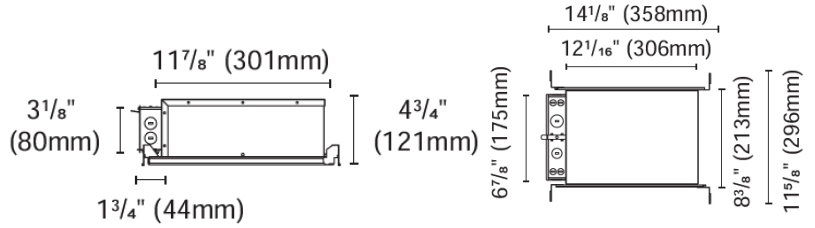

### LZNCIC-3

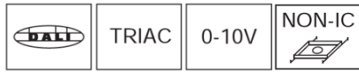

Remodel Gearbox

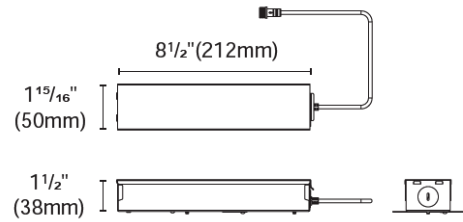

Internal space dimension:

L 8 1/4" (209mm) X W 1 7/8" (48mm) X H 1 5/16" (33mm)

### LZREM-3

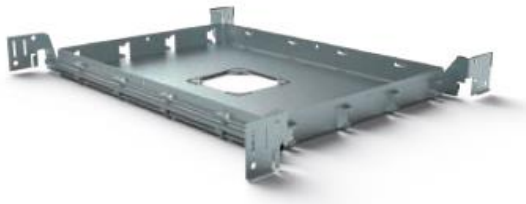
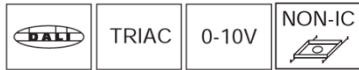

New Construction Plate

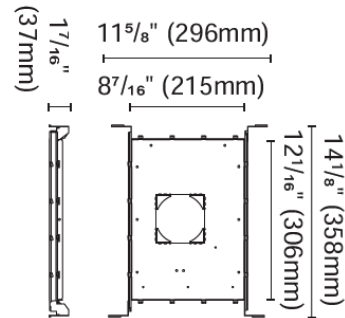

### LZNCP-3

#### 1. Trim Type

**LZNCIC-3** = New Construction Housing – IC Rated

**LZREM-3** = Remodel Housing (non IC)

#### 2. CONTROL

**TRIAC** = TRIAC (120V)  
**0-10V** = 0-10V (120-277V)  
**DALI** = DALI (120-277V)

#### 3. OPTIONS

**EMB** = EMERGENCY BATTERY / Comes with holder

#### Accessory

**LZNCP-3\*** = New Construction Plate (non IC)



EMB – Emergency Driver comes with holder

\*To be installed with LZREM-2

Example: **LZNCIC-3-TRIAC** = New Construction Housing – Triac Dimming