



### TECHNICAL SPECIFICATION

Minimum profile downlight with metal conduit and driver included for easy remodel or new construction installation.

### SPECIFICATIONS

- Construction: Die-cast Aluminum
- Optics: PMMA Lens
- Power: 45W Input: 120-277 VAC, 50/60Hz
- CCT: 2700K, 3000K, 3500K, 4000K
- CRI: +90
- LED Source: 1961lm-3305lm
- Beam Angle: 20°/30°/45°/55°/WW
- Adjustable fixture from 0° -30° Tilt – Rotation 0°-358°
- Dimming Options: DALI – TRIAC – 0-10V
- Light Source: Integrated LED Lens: TIR lens
- Rated Life: L80 >50000 Hours
- Finish: Electrostatically Powder Coated: White, Black, Hazel and Gold (RAL options available).
- Standards: ETL, cETL, Wet and Damp Location Listed
- Fixed and Wall wash – Wet Location Rated
- Adjustable - Damp Location Rated

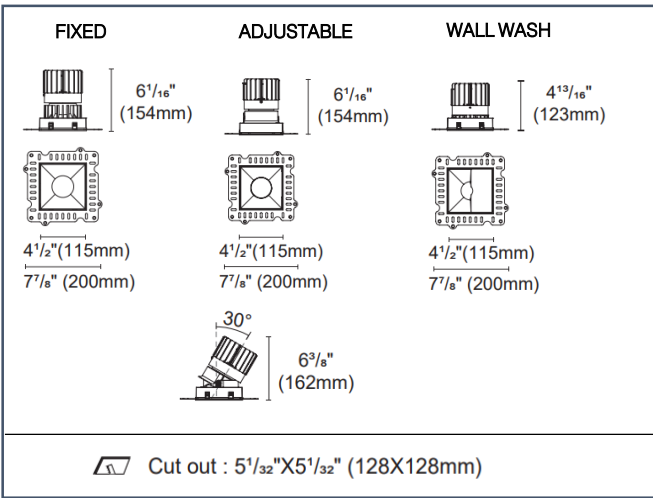

### FINISHES

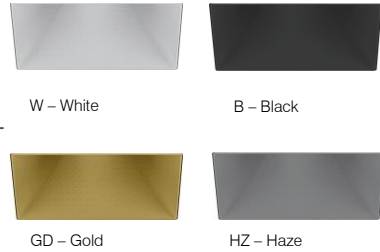

### OPTICS

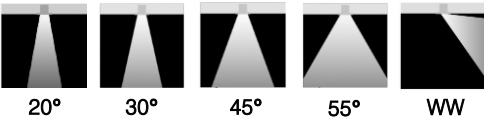

### CCT

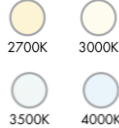

#### 1. Trim Type

**LUZ5-SFTL** = Square Trimless Reflector, Fixed, Trim (3258lm) **Wet**

**LUZ5-SATL** = Square Trimless Reflector, Adjustable, Trim (3242lm) **Damp**

**LUZ5-SWWTL** = Square Trimless Reflector, Wall Wash, Trim (2017lm) **Wet**

#### 2. Color Temperature

**27** = 2700K  
**30** = 3000K  
**35** = 3500K  
**40** = 4000K

#### 3. Optic

**NS** = 20°\*  
**N** = 30°\*  
**M** = 45°\*  
**W** = 55°\*  
**WW** = Wall Wash\*\*

#### 4. Finish

**W** = White Reflector  
**B** = Black Reflector  
**HZ** = Haze Reflector  
**GD** = Gold Reflector

#### 5. Dimming

**Please see Housing Ordering Sheet (page 2)**

#### Accessories



\* Not available for LUZ5-SWWTL

\*\* Only available optic for LUZ5-SWWTL

Example: **LUZ5-SFTL-30-M-W** = 5" Square Trimless Fixed Downlight – 3000K – 45° Optic – White Reflector

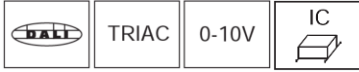

New Construction

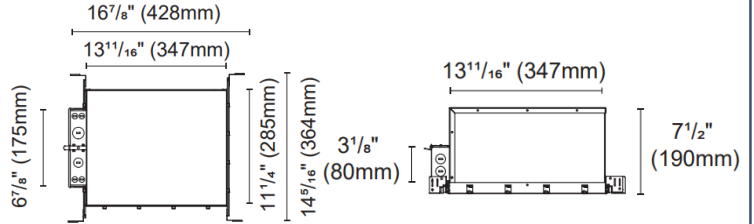

### LZNCIC-5

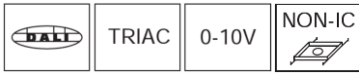

Remodel

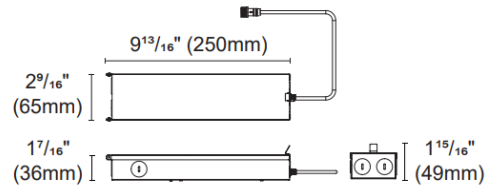

Internal space dimension:  
L 9<sup>13</sup>/<sub>16</sub>" (250mm) X W 2<sup>1</sup>/<sub>2</sub>" (64mm) X H 1<sup>5</sup>/<sub>16</sub>" (34mm)

### LZREM-5



New Construction Plate

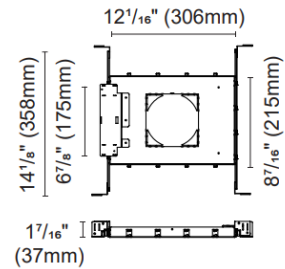

### LZNCP-5

#### 1. Trim Type

**LZNCIC-5** = New Construction Housing – IC Rated

**LZREM-5** = Remodel Housing (non IC)

#### 2. CONTROL

**TRIAC** = TRIAC (120V)  
**0-10V** = 0-10V (120-277V)  
**DALI** = DALI (120-277V)

#### 3. OPTIONS

**EMB** = Emergency Battery Holder / Battery Not Included

#### Accessory

**LZNCP-5\*** = New Construction Plate (non IC)

\* To be used with LZREM-45



EMB – Emergency holder.

Example: **LZNCIC-5-TRIAC** = New Construction Housing – Triac Dimming

# LUZ 5 – SQUARE TRIMLESS

Fixture Type: \_\_\_\_\_

Type: \_\_\_\_\_

Project: \_\_\_\_\_

Location: \_\_\_\_\_

V2.8

**LUZ5-SFTL**

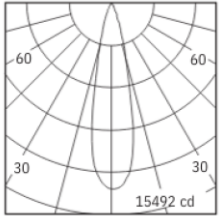

h(m)	D(m)	E(lx)
20°		
1.0	0.40	15499
2.0	0.80	3875
3.0	1.20	1722
4.0	1.60	968
5.0	2.00	620

**LUZ5-SATL**

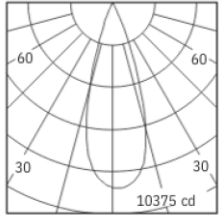

h(m)	D(m)	E(lx)
30°		
1.0	0.59	10355
2.0	1.18	2589
3.0	1.77	1151
4.0	2.36	647
5.0	2.95	414

**LUZ5-SWWTL**

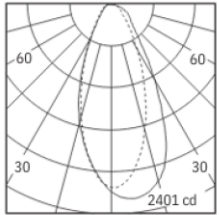

h(m)	D(m)	E(lx)
Wallwash		
1.0	0.75	2350
2.0	1.49	587
3.0	2.24	261
4.0	2.99	146
5.0	3.73	93