



TECHNICAL SPECIFICATION

Minimum profile downlight with metal conduit and driver included for easy remodel or new construction installation.

SPECIFICATIONS

- Construction: Die-cast Aluminum
- Optics: PMMA Lens
- Power: 45W Input: 120-277 VAC, 50/60Hz
- CCT: 2700K, 3000K, 3500K, 4000K
- CRI: +90
- LED Source: 1961lm-3305lm
- Beam Angle: 20°/30°/45°/55°/WW
- Adjustable fixture from 0° -30° Tilt – Rotation 0°-358°
- Dimming Options: DALI – TRIAC – 0-10V
- Light Source: Integrated LED Lens: TIR lens
- Rated Life: L80 >50000 Hours
- Finish: Electrostatically Powder Coated: White, Black, Hazel and Gold (RAL options available).
- Standards: ETL, cETL, Wet and Damp Location Listed
- Fixed and Wall wash – Wet Location Rated
- Adjustable - Damp Location Rated

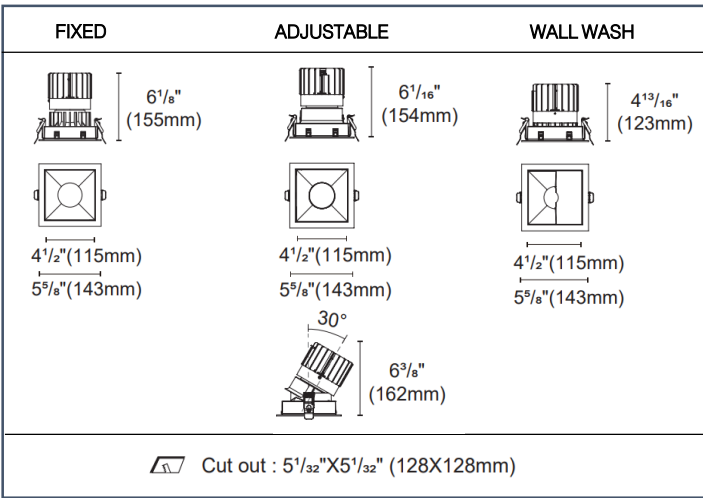

FINISHES

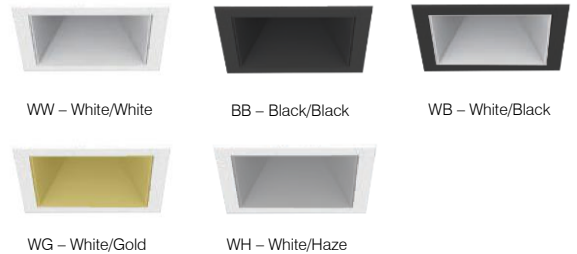

OPTICS

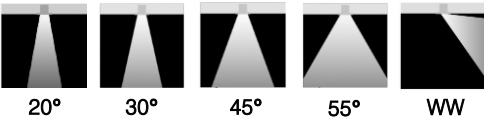

CCT

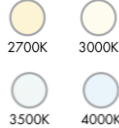

1. Trim Type

- LUZ5-SFT** = Square Reflector, Fixed, Trim (3258lm) **Wet**
- LUZ5-SAT** = Square Reflector, Adjustable, Trim (3242lm) **Damp**
- LUZ5-SWWT** = Square Reflector, Wall Wash, Trim (2017lm) **Wet**

2. Color Temperature

- 27** = 2700K
30 = 3000K
35 = 3500K
40 = 4000K

3. Optic

- NS** = 20°*
N = 30°*
M = 45°*
W = 55°*
WW = Wall Wash**

4. Finish

- WW** = White Trim / White Reflector
BB = Black Trim / Black Reflector
WB = White Trim / Black Reflector
WH = White Trim / Haze Reflector
WG = White Trim / Gold Reflector

5. Dimming

Please see Housing Ordering Sheet (page 2)

Accessories



* Not available for LUZ5-SWWT

** Only available optic for LUZ5-SWWT

Example: **LUZ5-SFT-30-M-WW** = 5" Square Fixed Downlight – 3000K – 45° Optic – White Trim / White Reflector

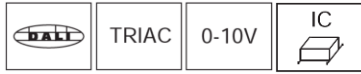

New Construction

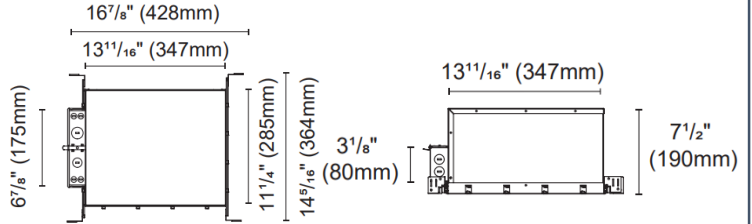

LZNCIC-5

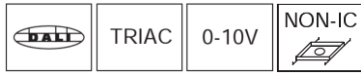

Remodel

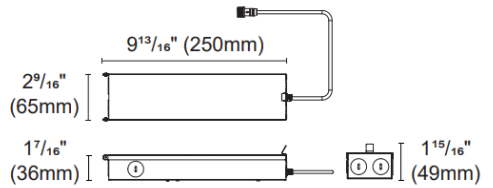

Internal space dimension:
L 9 13/16" (250mm) X W 2 1/2" (64mm) X H 1 5/16" (34mm)

LZREM-5



New Construction Plate

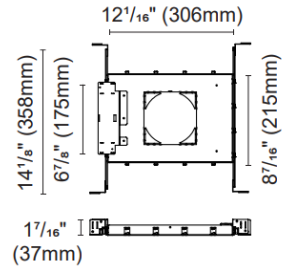

LZNCP-5

1. Trim Type

LZNCIC-5 = New Construction Housing – IC Rated

LZREM-5 = Remodel Housing (non IC)

2. CONTROL

TRIAC = TRIAC (120V)
0-10V = 0-10V (120-277V)
DALI = DALI (120-277V)

3. OPTIONS

EMB = Emergency Battery Holder / Battery Not Included

Accessory

LZNCP-5* = New Construction Plate (non IC)

* To be used with LZREM-45



EMB – Emergency holder.

Example: **LZNCIC-5-TRIAC** = New Construction Housing – Triac Dimming



LUZ 5 – SQUARE

Fixture Type: _____

Type: _____

Project: _____

Location: _____

V2.8
